



ACCESORIOS Y COMPLEMENTOS DE BAÑO
BATHROOM ACCESSORIES

SERIE EVOLUTION
TARIFA DE PRECIOS 2017



BEL AQUA EQUIPAMIENTO DE BAÑO S.L.

Polígono Ugaldeguren I
48170 Zamudio (Vizcaya)
ESPAÑA

Tel. + 34 94 471 00 64

Fax. 34 94 471 16 47

www.belaqua.es

comercial@belaqua.es

export@belaqua.es



SAFETY

DESIGN

CONFORT







La gama *EVOLUTION* propone unos accesorios destinados al **Confort** y a la **Seguridad**, extraíbles e intercambiables, que permiten una transformación fácil y sin obra en el cuarto de baño o aseo, de acuerdo a las necesidades individuales. Su aspecto modular y evolutivo ofrece múltiples soluciones, y todo ello con un diseño elegante y no estigmatizante.

Los productos *EVOLUTION* cumplen con la Directiva 93/42/EEC relativa a los productos médicos. El diseño cumple con los requisitos de la norma europea EN 12182: 2012 "Productos de apoyo para las personas con discapacidad".

CLÁSICO



Mejore su cuarto de

Change your bathroom easily



Descripción	Ref.	P.V.P.
RIEL + TAPA 600 <i>Rail + cover 600</i>		
Anodizado/Blanco <i>Anodized/White</i>	044060	91,10 €
JABONERA DE DUCHA <i>Shower shelf</i>		
Blanco <i>White</i>	047736	33,00 €



RIEL + TAPA 100 <i>Rail + cover 100</i>		
Anodizado/Blanco <i>Anodized/White</i>	044010	42,00 €
JABONERA DE DUCHA <i>Shower shelf</i>		
Blanco <i>White</i>	047736	33,00 €



baño fácilmente

Descripción	Ref.	P.V.P.
ASIENTO DE DUCHA <i>Shower seat</i> ■ Blanco/Gris <i>White/Grey</i>	047731	248,00 €
RESPALDO + 2 apoyabrazos <i>Backrest + 2 armrest</i> ■ Blanco/Gris <i>White/Grey</i>	047721	288,00 €
ASIENTO DE DUCHA <i>Shower seat</i> ■ Blanco/Gris <i>White/Grey</i>	047731	248,00 €
BARRA ARTICULADA <i>Hinged bar</i> ■ Blanco/Cromo mate <i>White/Mat chrome-plated</i>	048960	262,00 €
PLETINA <i>Plate adaptor</i> ■ Blanco <i>White</i>	044710	39,50 €



¿Desea cambiar su cuarto de
baño?

Descubra nuestra gama de
soluciones intercambiables
Evolution.

*You wish to change your bathroom?
Discover our Evolution upgradable
solutions.*



SOLUCIONES EVOLUTIVAS

EVOLUTION 100

.SOBRE LA BASE DE UN RIEL EVOLUTION 100 Y DE UNA REPISA

With a rail 100 and a shelf

	Descripción	Ref.	P.V.P.
	RIEL + TAPA 100 <i>Rail + cover 100</i>		
	Anodizado/ Blanco <i>Anodized/White</i>	044010	42,00 €
	Anodizado/Antracita <i>Anodized/Anthracite grey</i>	044013	42,00 €
	REPISA DE DUCHA <i>Shower shelf</i>		
	Blanco <i>White</i>	047736	33,00 €
	Antracita <i>Anthracite grey</i>	047740	33,00 €

.SOLUCIÓN EVOLUTIVA *SEGURIDAD*

Safety

	PLETINA <i>Plate adaptor</i>		
	Blanco <i>White</i>	044710	39,50 €
	Antracita <i>Anthracite grey</i>	044713	39,50 €
	BARRA ARTICULADA <i>Hinged bar</i>		
	Blanco <i>White</i>	048660	227,00 €
	Blanco/Cromo mate <i>White/Mat chrome-plated</i>	048960	262,00 €
	Antracita/Cromo <i>Anthracite grey/Chrome-plated</i>	048760	273,50 €
	ASIENTO DE DUCHA <i>Shower seat</i>		
	Blanco <i>White</i>	047730	232,00 €
	Blanco/Gris <i>White/Grey</i>	047731	248,00 €
	Antracita/Gris <i>Anthracite grey</i>	047734	248,00 €
	Antracita <i>Anthracite grey</i>	047729	248,00 €

.SOLUCIÓN EVOLUTIVA *ACCESIBLE*

Accessible

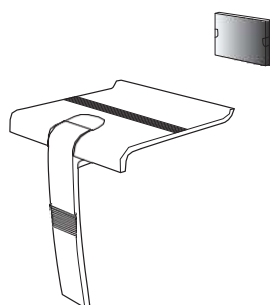

Descripción	Ref.	P.V.P.
ASIENTO DE DUCHA <i>Shower seat</i>		
Blanco <i>White</i>	047730	232,00 €
Blanco/Gris <i>White / Grey</i>	047731	248,00 €
Antracita/Gris <i>Anthracite grey/Grey</i>	047734	248,00 €
Antracita <i>Anthracite grey</i>	047729	248,00 €

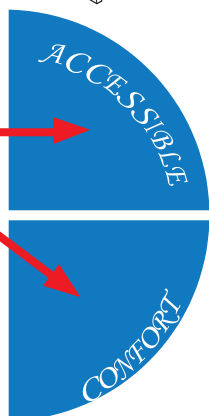

.SOLUCIÓN EVOLUTIVA *COMFORT*

Comfort

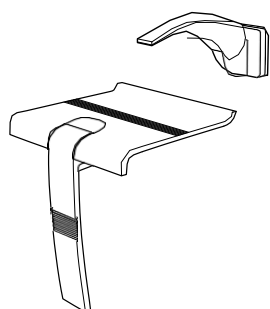

PLETINA <i>Plate adaptor</i>		
Blanco <i>White</i>	044710	39,50 €
Antracita <i>Anthracite grey</i>	044713	39,50 €
APOYABRAZO <i>Armrest</i>		
Blanco <i>White</i>	047710	75,00 €
Blanco/Gris <i>White/Grey</i>	047711	75,00 €
Antracita <i>Anthracite grey</i>	047713	81,00 €
ASIENTO DE DUCHA <i>Shower seat</i>		
Blanco <i>White</i>	047730	232,00 €
Blanco/Gris <i>White/Grey</i>	047731	248,00 €
Antracita/Gris <i>Anthracite grey/Grey</i>	047734	248,00 €
Antracita <i>Anthracite grey</i>	047729	248,00 €



EVOLUTION 600

.SOBRE LA BASE DE UN RIEL EVOLUTION 600 Y DE UNA REPISA

With a rail 600 and a shelf



Descripción	Ref.	P.V.P.
RIEL + TAPA 600 <i>Rail + cover 600</i>		
Anodizado/Blanco <i>Anodized/White</i>	044060	91,10 €
Anodizado/Antracita <i>Anodized/Anthracite grey</i>	044063	91,10 €
REPISA DE DUCHA <i>Shower shelf</i>		
Blanco <i>White</i>	047736	33,00 €
Antracita <i>Anthracite grey</i>	047740	33,00 €

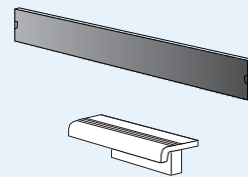

.SOLUCIÓN EVOLUTIVA *SEGURIDAD*

Safety



RESPALDO <i>Backrest</i>		
Blanco <i>White</i>	044720	45,00 €
Antracita <i>Anthracite grey</i>	044723	45,00 €



BARRA ARTICULADA <i>Hinged bar</i>		
Blanco <i>White</i>	048660	227,00 €
Blanco/Cromo mate <i>White/Mat chrome-plated</i>	048960	262,00 €
Antracita/Cromo <i>Anthracite grey/Chrome-plated</i>	048760	273,50 €



PLETINA <i>Plate adaptor</i>		
Blanco <i>White</i>	044710	39,50 €
Antracita <i>Anthracite grey</i>	044713	39,50 €



ASIENTO DE DUCHA <i>Shower seat</i>		
Blanco <i>White</i>	047730	232,00 €
Blanco/Gris <i>White/Grey</i>	047731	248,00 €
Antracita/Gris <i>Anthracite grey/Grey</i>	047734	248,00 €
Antracita <i>Anthracite grey</i>	047729	248,00 €

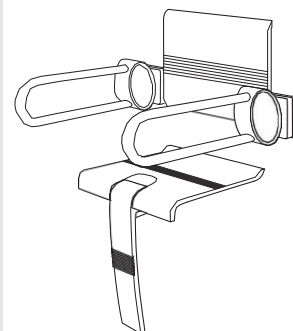

EVOLUTION 600

.SOLUCIÓN EVOLUTIVA *ACCESIBLE*

Accessible

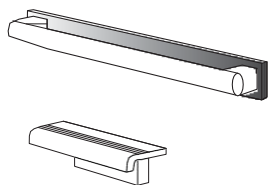

Descripción	Ref.	P.V.P.
BARRA DE APOYO EXTRAÍBLE <i>Removable grab bar</i>		
Blanco/Anodizado <i>White/Anodized</i>	044860	81,00 €
Antracita / Anodizado <i>Anthracite grey / Anodized</i>	044863	81,00 €

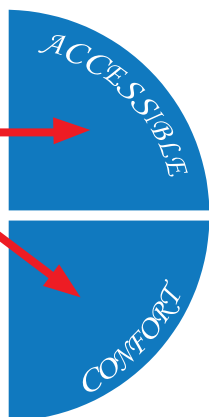

.SOLUCIÓN EVOLUTIVA *COMFORT*

Comfort

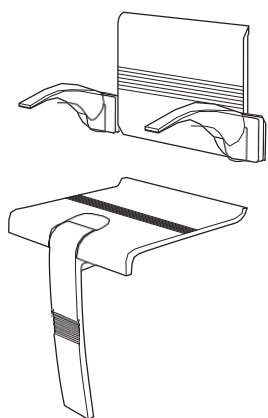

RESPALDO <i>Backrest</i>		
Blanco <i>White</i>	044720	45,00 €
Antracita <i>Anthracite grey</i>	044723	45,00 €
APOYOBRAZOS <i>Armrest</i>		
Blanco <i>White</i>	047710	75,00 €
Blanco/ Gris <i>White / Grey</i>	047711	75,00 €
Antracita <i>Anthracite grey</i>	047713	81,00 €
PLETINA <i>Plate adaptor</i>		
Blanco <i>White</i>	044710	39,50 €
Antracita <i>Anthracite grey</i>	044713	39,50 €
ASIENTO DE DUCHA <i>Shower seat</i>		
Blanco <i>White</i>	047730	232,00 €
Blanco/ Gris <i>White / Grey</i>	047731	248,00 €
Antracita/ Gris <i>Anthracite grey / Grey</i>	047734	248,00 €
Antracita <i>Anthracite grey</i>	047729	248,00 €



EVOLUTION 500

SOBRE LA BASE DE UN RIEL EVOLUTION 500 Y DE UNA REPISA

With a rail 500 and a shelf

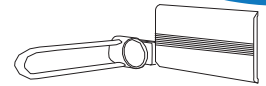
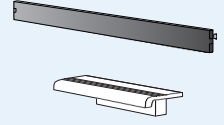

Descripción	Ref.	P.V.P.
RIEL + TAPA 500 <i>Rail + cover 500</i>		
Anodizado/Blanco <i>Anodized/White</i>	044050	82,00 €
Anodizado/Antracita <i>Anodized/Anthracite grey</i>	044053	82,00 €
REPISA DE DUCHA <i>Shower shelf</i>		
Blanco <i>White</i>	047736	33,00 €
Antracita <i>Anthracite grey</i>	047740	33,00 €

SOLUCIÓN EVOLUTIVA SEGURIDAD

Safety



RESPALDO <i>Backrest</i>		
Blanco <i>White</i>	044720	45,00 €
Antracita <i>Anthracite grey</i>	044723	45,00 €
BARRA ARTICULADA <i>Hinged bar</i>		
Blanco <i>White</i>	048660	227,00 €
Blanco/Cromo mate <i>White / Mat chrome-plated</i>	048960	262,00 €
Antracita/Cromo <i>Anthracite grey / Chrome-plate</i>	048760	273,50 €
PLETINA <i>Plate adaptor</i>		
Blanco <i>White</i>	044710	39,50 €
Antracita <i>Anthracite grey</i>	044713	39,50 €
ASIENTO DE DUCHA <i>Shower seat</i>		
Blanco <i>White</i>	047730	232,00 €
Blanco/Gris <i>White /Grey</i>	047731	248,00 €
Antracita/Gris <i>Anthracite grey/ Grey</i>	047734	248,00 €
Antracita <i>Anthracite grey</i>	047729	248,00 €

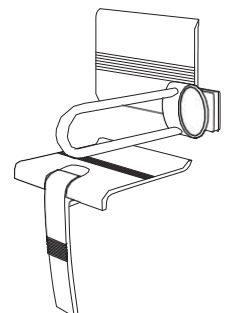

EVOLUTION 500

.SOLUCIÓN EVOLUTIVA *ACCESIBLE*

Accessible

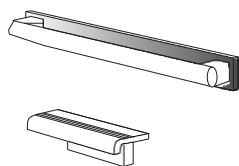

Descripción	Ref.	P.V.P.
BARRA DE APOYO EXTRAÍBLE <i>Removable grab bar</i>		
Blanco/Anodizado <i>White/Anodized</i>	044850	74,00 €
Antracita/Anodizado <i>Anthracite grey/ Anodized</i>	044853	74,00 €

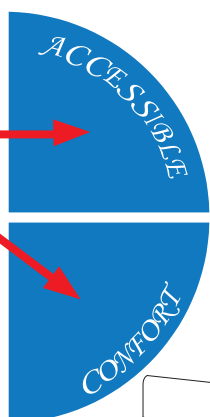

.SOLUCIÓN EVOLUTIVA *COMFORT*

Comfort

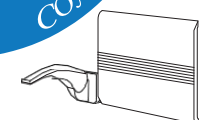

RESPALDO <i>Backrest</i>		
Blanco <i>White</i>	044720	45,00 €
Antracita <i>Anthracite grey</i>	044723	45,00 €

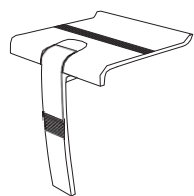

APOYABRAZO <i>Armrest</i>		
Blanco <i>White</i>	047710	75,00 €
Blanco/Gris <i>White/ Grey</i>	047711	75,00 €
Antracita <i>Anthracite grey</i>	047713	81,00 €

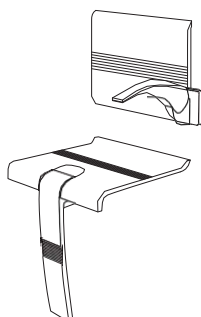

PLETINA <i>Plate adaptor</i>		
Blanco <i>White</i>	044710	39,50 €
Antracita <i>Anthracite grey</i>	044713	39,50 €
ASIENTO DE DUCHA <i>Shower seat</i>		
Blanco <i>White</i>	047730	232,00 €
Blanco/Gris <i>White/Grey</i>	047731	248,00 €
Antracita/Gris <i>Anthracite grey/Grey</i>	047734	248,00 €
Antracita <i>Anthracite grey</i>	047729	248,00 €



EVOLUTION 400

SOBRE LA BASE DE UN RIEL EVOLUTION 400 Y DE UNA REPISA

With a rail 400 and a shelf

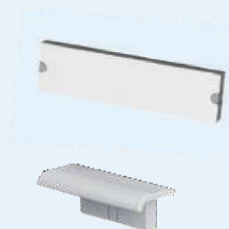

Descripción	Ref.	P.V.P.
RIEL + TAPA 400 <i>Rail + cover 400</i>		
Anodizado/Blanco <i>Anodized/White</i>	044040	69,50 €
Anodizado/Antracita <i>Anodized/Anthracite grey</i>	044043	69,50 €
REPISA DE DUCHA <i>Shower shelf</i>		
Blanco <i>White</i>	047736	33,00 €
Antracita <i>Anthracite grey</i>	047740	33,00 €

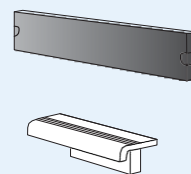

SOLUCIÓN EVOLUTIVA *SEGURIDAD*

Safety



ASIENTO DE DUCHA <i>Shower seat</i>		
Blanco <i>White</i>	047730	232,00 €
Blanco/Gris <i>White/Grey</i>	047731	248,00 €
Antracita/Gris <i>Anthracite grey /Grey</i>	047734	248,00 €
Antracita <i>Anthracite grey</i>	047729	248,00 €

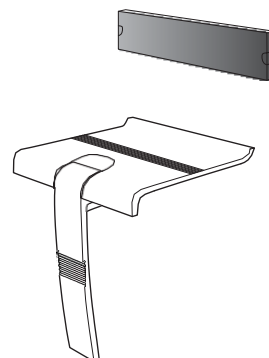

.SOLUCIÓN EVOLUTIVA *ACCESIBLE*

Accessible

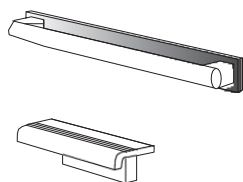

Descripción	Ref.	P.V.P.
BARRA DE APOYO EXTRAIBLE <i>Removable grab bar</i>		
Blanco/Anodizado <i>White/Anodized</i>	044840	70,00 €
Antracita/Anodizado <i>Anthracite grey/Anodized</i>	044843	70,00 €

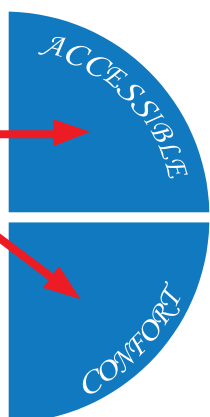

.SOLUCIÓN EVOLUTIVA *COMFORT*

Comfort

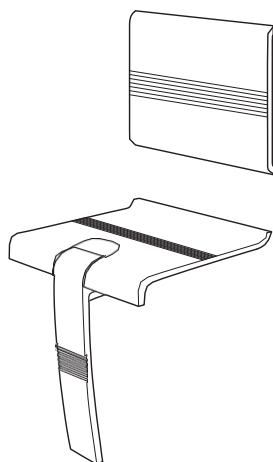

RESPALDO <i>Backrest</i>		
Blanc <i>White</i>	044720	45,00 €
Antracita <i>Anthracite grey</i>	044723	45,00 €
ASIENTO DE DUCHA <i>Shower seat</i>		
Blanco <i>White</i>	047730	232,00 €
Blanco/Gris <i>White/Grey</i>	047731	248,00 €
Antracita/Gris <i>Anthracite grey / Grey</i>	047734	248,00 €
Antracita <i>Anthracite grey</i>	047729	248,00 €



¿Desea un kit completo, preparado para ser usado? Descubra las distintas composiciones de nuestra serie *Evolution*.

You wish a complete kit, ready-to-use? Discover the different compositions of our Evolution range.



KITS COMPLETOS

COMPOSITION 100

.COMPOSICIÓN CLÁSICA

Classical



Descripción	Ref.	P.V.P.
RIEL + TAPA 100 <i>Rail + cover 100</i>		
Anodizado/Blanco <i>Anodized/White</i>	044010	42,00 €
Anodizado/Antracita <i>Anodized/Anthracite grey</i>	044013	42,00 €
REPISA DE DUCHA <i>Shower shelf</i>		
Blanco <i>White</i>	047736	33,00 €
Antracita <i>Anthracite grey</i>	047740	33,00 €

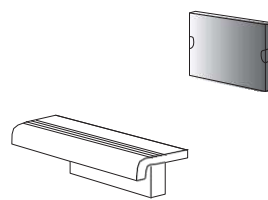

.COMPOSICIÓN SEGURIDAD

Safety



KIT PLETINA <i>Plate Kit</i>		
Blanco <i>White</i>	044110	67,00 €
Antracita <i>Anthracite greys</i>	044113	67,00 €

kit pletina = riel de fijación + pletina de adaptación + tapa

Plate kit = Fixing rail + Plate adaptor + Cover

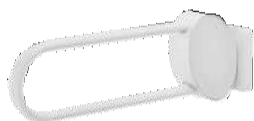

BARRA ARTICULADA <i>Hinged bar</i>		
Blanco <i>White</i>	048660	227,00 €
Blanco/Cromo mate <i>White / Mat chrome-plated</i>	048960	262,00 €
Antracita/Cromo <i>Anthracite grey / Chrome-plated</i>	048760	273,50 €



ASIENTO DE DUCHA <i>Shower seat</i>		
Blanco <i>White</i>	047730	232,00 €
Blanco/Gris <i>White/Grey</i>	047731	248,00 €
Antracita/Gris <i>Anthracite grey/Grey</i>	047734	248,00 €
Antracita <i>Anthracite grey</i>	047729	248,00 €

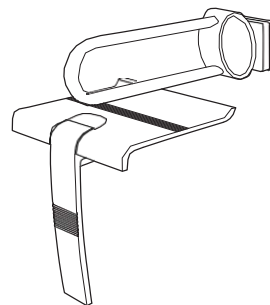

COMPOSICIÓN 100

.COMPOSICIÓN ACCESIBLE

Accessible

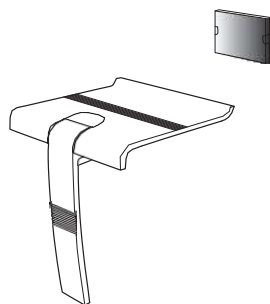

Descripción	Ref.	P.V.P.
RIEL + TAPA 100 Rail + cover 100		
Anodizado/Blanco Anodized / White	044010	42,00 €
Anodizado/Antracita Anodized/Anthracite grey	044013	42,00 €
ASIENTO DE DUCHA Shower seat		
Blanco White	047730	232,00 €
Blanco/Gris White /Grey	047731	248,00 €
Antracita/Gris Anthracite grey /Grey	047734	248,00 €
Antracita Anthracite grey	047729	248,00 €



ACCESSIBLE

COMFORT

.COMPOSICIÓN CONFORT

Comfort

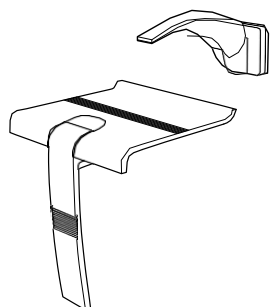

KIT PLETINE "Click & fit" plate kit		
Blanco White	044110	67,00 €
Antracita Anthracite grey	044113	67,00 €
Kit pletina= riel de fijación+ pletina de adaptación+ tapa <small>Plate kit= Fixing rail + Plate adaptor+ Cover</small>		
APOYABRAZO Armrest		
Blanco White	047710	75,00 €
Blanco/Gris White/Grey	047711	75,00 €
Antracita Anthracite grey	047713	81,00 €
ASIENTO DE DUCHA Shower seat		
Blanco White	047730	232,00 €
Blanco/Gris White/Grey	047731	248,00 €
Antracita/Gris Anthracite grey/Grey	047734	248,00 €
Antracita Anthracite grey	047729	248,00 €



KITS COMPLETOS

COMPOSITION 600

.COMPOSICIÓN CLÁSICO

Classical

Descripción	Ref.	P.V.P.
RIEL + TAPA 600 <i>Rail + cover 600</i>		
Anodizado/Blanco <i>Anodized/White</i>	044060	91,10 €
Anodizado/Antracita <i>Anodized /Anthracite grey</i>	044063	91,10 €
REPISA DE DUCHA <i>Shower shelf</i>		
Blanco <i>White</i>	047736	33,00 €
Antracita <i>Anthracite grey</i>	047740	33,00 €

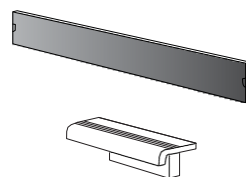

.COMPOSICIÓN SEGURIDAD

Safety

RIEL 600 <i>Rail 600</i>	044260	49,00 €
Anodizado <i>Anodized</i>		
RESPALDO <i>Backrest</i>	044720	45,00 €
Blanco <i>White</i>		
Antracita <i>Anthracite grey</i>	044723	45,00 €
BARRA ARTICULADA <i>Hinged bar</i>	048660	227,00 €
Blanco <i>White</i>		
Blanco/Cromo mate <i>White / Mat chrome-plated</i>	048960	262,00 €
Antracita/Cromo <i>Anthracite grey / Chrome-plated</i>	048760	273,50 €
PLETINA <i>Plate adaptor</i>	044710	39,50 €
Blanco <i>White</i>		
Antracita <i>Anthracite grey</i>	044713	39,50 €
ASIENTO DE DUCHA <i>Shower seat</i>	047730	232,00 €
Blanco <i>White</i>		
Blanco/Gris <i>White/Grey</i>	047731	248,00 €
Antracita/Gris <i>Anthracite grey/Grey</i>	047734	248,00 €
Antracita <i>Anthracite grey</i>	047729	248,00 €

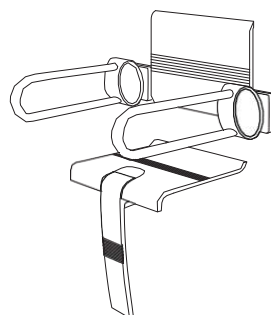

COMPOSICIÓN 600

.COMPOSICIÓN ACCESIBLE

Accessible

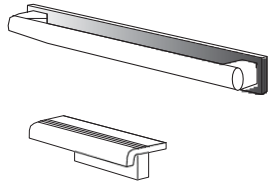

Descripción	Ref.	P.V.P.
RIEL 600 Rail 600 Anodizado Anodized	044260	49,00 €
BARRA DE APOYO DESMONTABLE Removable grab bar Blanco/Anodizado White/Anodized	044860	81,00 €
Antracita/Anodizado Anthracite grey /Anodized	044863	81,00 €
REPISA DE DUCHA Shower shelf Blanco White	047736	33,00 €
Antracita Anthracite grey	047740	33,00 €

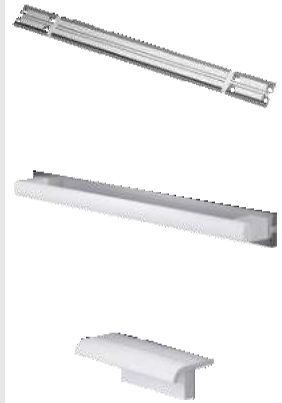

ACCESSIBLE

CONFORT

.COMPOSICIÓN CONFORT

Comfort

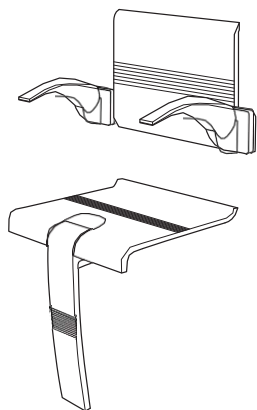

RESPALDO + 2 apoyabrazos* Backrest + 2 armrests Blanco White	047720	288,00 €
Blanco/Gris White / Grey	047721	288,00 €
Antracita Anthracite grey	047723	299,50 €
*Riel de pared incluido *Wall rail included		
ASIENTO DE DUCHA Shower seat Blanco White	047730	232,00 €
Blanco/Gris White/Grey	047731	248,00 €
Antracita/Gris Anthracite grey/Grey	047734	248,00 €
Antracita Anthracite grey	047729	248,00 €



KITS COMPLETOS

COMPOSITION 500

.COMPOSICIÓN CLÁSICO

Classical



Descripción	Ref.	P.V.P.
RIEL + TAPA 500 <i>Rail + cover 500</i>		
■ Anodizado/Blanco <i>Anodized / White</i>	044050	82,00 €
■ Anodizado/Antracita <i>Anodized/Anthracite grey</i>	044053	82,00 €
REPISA DE DUCHA <i>Shower shelf</i>		
■ Blanco <i>White</i>	047736	33,00 €
■ Antracita <i>Anthracite grey</i>	047740	33,00 €

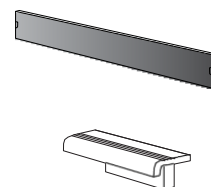

.COMPOSICIÓN SEGURIDAD

Safety



RIEL 500 <i>Rail 500</i>		
■ Anodizado <i>Anodized</i>	044250	44,00 €
RESPALDO <i>Backrest</i>		
■ Blanco <i>White</i>	044720	45,00 €
■ Antracita <i>Anthracite grey</i>	044723	45,00 €
BARRA ARTICULADA <i>Hinged bar</i>		
■ Blanco <i>White</i>	048660	227,00 €
■ Blanco/Cromo mate <i>White / Mat chrome-plated</i>	048960	262,00 €
■ Antracita/Cromo <i>Anthracite grey / Chrome-plated</i>	048760	273,50 €
PLETINA <i>Plate adaptor</i>		
■ Blanco <i>White</i>	044710	39,50 €
■ Antracita <i>Anthracite grey</i>	044713	39,50 €
ASIENTO DE DUCHA <i>Shower seat</i>		
■ Blanco <i>White</i>	047730	232,00 €
■ Blanco/Gris <i>White / Grey</i>	047731	248,00 €
■ Antracita/Gris <i>Anthracite grey/Grey</i>	047734	248,00 €
■ Antracita <i>Anthracite grey</i>	047729	248,00 €

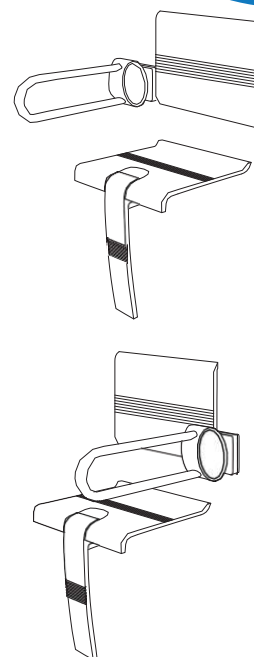

EVOLUTION 500

.COMPOSICIÓN ACCESIBLE

Accessible

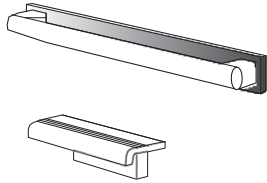

Descripción	Ref.	P.V.P.
RIEL 500 Rail 500 Anodizado Anodized	044250	44,00 €
BARRA DE APOYO DESMONTABLE Removable grab bar Blanco/Anodizado White / Anodized	044850	74,00 €
Antracita/Anodizado Anthracite grey / Anodized	044853	74,00 €
REPISA DE DUCHA Shower shelf Blanco White	047736	33,00 €
Antracita Anthracite grey	047740	33,00 €



ACCESSIBLE

.COMPOSICIÓN CONFORT

Comfort

RIEL 500 Rail 500 Anodizado Anodized	044250	44,00 €
RESPALDO Backrest Blanco White	044720	45,00 €
Antracita Anthracite grey	044723	45,00 €
APOYABRAZO Armrest Blanco White	047710	75,00 €
Blanco/Gris White / Grey	047711	75,00 €
Antracita Anthracite grey	047713	81,00 €
PLETINA Plate adaptor Blanco White	044710	39,50 €
Antracita Anthracite grey	044713	39,50 €
ASIENTO DE DUCHA Shower seat Blanco White	047730	232,00 €
Blanco/Gris White / Grey	047731	248,00 €
Antracita/Gris Anthracite grey / Grey	047734	248,00 €
Antracita Anthracite grey	047729	248,00 €

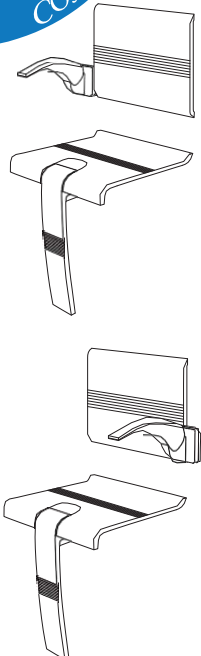

KITS COMPLETOS

COMPOSITION 400

.COMPOSICIÓN CLÁSICA

Classical



Descripción	Ref.	P.V.P.
RIEL + TAPA 400 <i>Rail + cover 400</i>		
Anodizado/Blanco <i>Anodized/ White</i>	044040	69,50 €
Anodizado/Antracita <i>Anodized/Anthracite grey</i>	044043	69,50 €
REPISA DE DUCHA <i>Shower shelf</i>		
Blanco <i>White</i>	047736	33,00 €
Antracita <i>Anthracite grey</i>	047740	33,00 €

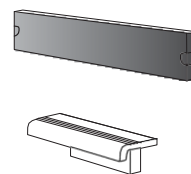

.COMPOSICIÓN SEGURIDAD

Safety



RIEL + TAPA 400 <i>Rail + cover 400</i>		
Anodizado/Blanco <i>Anodized/White</i>	044040	69,50 €
Anodizado/Antracita <i>Anodized/Anthracite grey</i>	044043	69,50 €
ASIENTO DE DUCHA <i>Shower seat</i>		
Blanco <i>White</i>	047730	232,00 €
Blanco/Gris <i>White/Grey</i>	047731	248,00 €
Antracita/Gris <i>Anthracite grey/Grey</i>	047734	248,00 €
Antracita <i>Anthracite grey</i>	047729	248,00 €

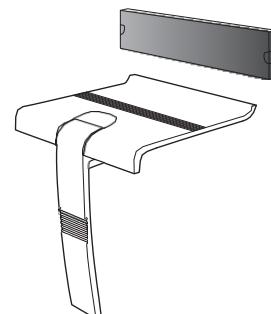

COMPOSITION 400

.COMPOSICIÓN ACCESIBLE

Accessible

Descripción	Ref.	P.V.P.
RIEL 400 Rail 400 Anodizado Anodized	044240	35,00 €
BARRA DE APOYO EXTRAÍBLE Removable grab bar Blanco/Anodizado White/Anodized	044840	70,00 €
Antracita/Anodizado Anthracite grey/Anodized	044843	70,00 €
REPISA DE DUCHA Shower shelf Blanco White	047736	33,00 €
Antracita Anthracite grey	047740	33,00 €

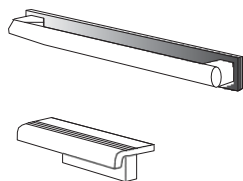

ACCESSIBLE

CONFORT

.COMPOSICIÓN CONFORT

Comfort

RIEL 400 Rail 400 Anodizado Anodized	044240	35,00 €
RESPALDO Backrest Blanco White	044720	45,00 €
Antracita Anthracite grey	044723	45,00 €
ASIENTO DE DUCHA Shower seat Blanco White	047730	232,00 €
Blanco/Gris White/Grey	047731	248,00 €
Antracita/Gris Anthracite grey/Grey	047734	248,00 €
Antracita Anthracite grey	047729	248,00 €

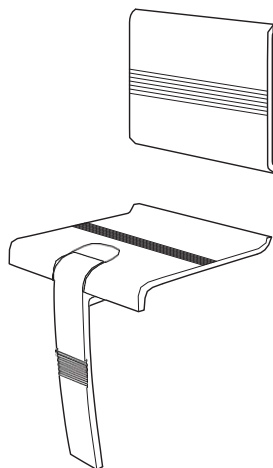

KITS COMPLETOS

Desea equipar su cuarto de baño de acuerdo a sus necesidades.

Descubra nuestros componentes *Evolution* y las instrucciones de montaje.

You wish to equip your bathroom to suit your needs? Discover our Evolution components and fitting instructions.



COMPONENTES / CONJUNTOS DE INSTALACION

.ASIENTOS DE DUCHA

Showerseats

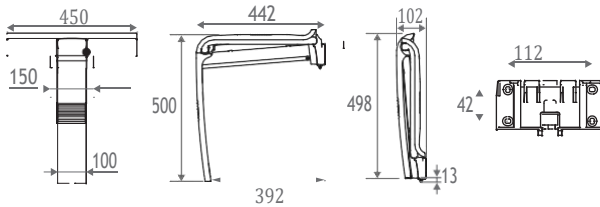

Descripción	Ref.	P.V.P.
ASIENTO BLANCO White seat Base Epoxy Blanca White epoxy base	047730	232,00 €
Base Epoxy Gris Grey epoxy base	047731	248,00 €
ASIENTO GRIS ANTRACITA Anthracite grey seat Base Epoxy Gris Grey epoxy base	047734	248,00 €
Base Epoxy Antracita Anthracite grey epoxy base	047729	248,00 €

.REPISA DE DUCHA DE FIJAR O DE PEGAR

Shelves

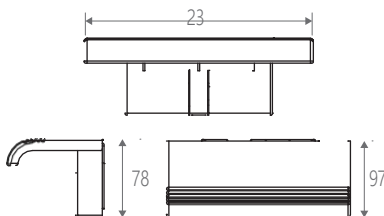

■ Blanco White	047735	25,00 €
■ Antracita Anthracite grey	047739	25,00 €
■ Blanco, con soporte montado en la pared White, with wall-mounted support	047736	33,00 €
■ Antracita, con soporte montado en la pared Anthracite grey, with wall	047740	33,00 €

.BARRAS ARTICULABLES



Hinged bars



Descripción	Ref.	P.V.P.
TUBO EPOXY BLANCO <i>White epoxy-coated tube</i>		
Fijación cubierta blanco <i>White flange</i>		
• 600 mm	048660	227,00 €
Fijación cubierta cromo mate <i>Mat chrome-plated flange</i>		
• 600 mm	048960	262,00 €
TUBO EPOXY ANTRACITA <i>Anthracite grey epoxy-coated tube</i>		
Fijación cubierta cromo <i>Chrome-plated flange</i>		
• 600 mm	048760	273,50 €

Las barras articulables extraíbles, de 770 mm., requieren la inclusión de un soporte, ref. 048610 (blanco) o 048710 (gris antracita).

The removable hinged bars, 770mm, require the addition of a support prop, ref. 048610 (white) or 048710 (anthracite grey).

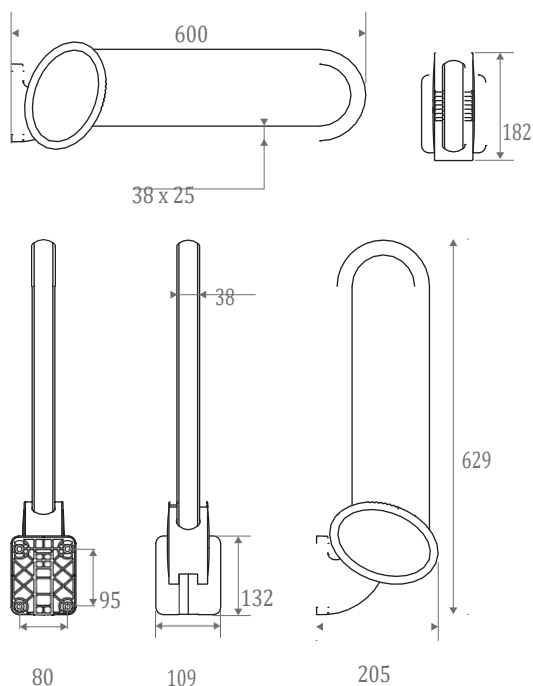

Para tener la barra articulable extraíble, añadir el kit "click&fit" ref. 044110 (blanco) o 044113 (antracita)

To have the hinged bar removable, add the "click&fit" plate kit ref. 044110 (white) or 044113 (anthracite grey).

.APOYABRAZOS EXTRAÍBLES

Hinged armrests

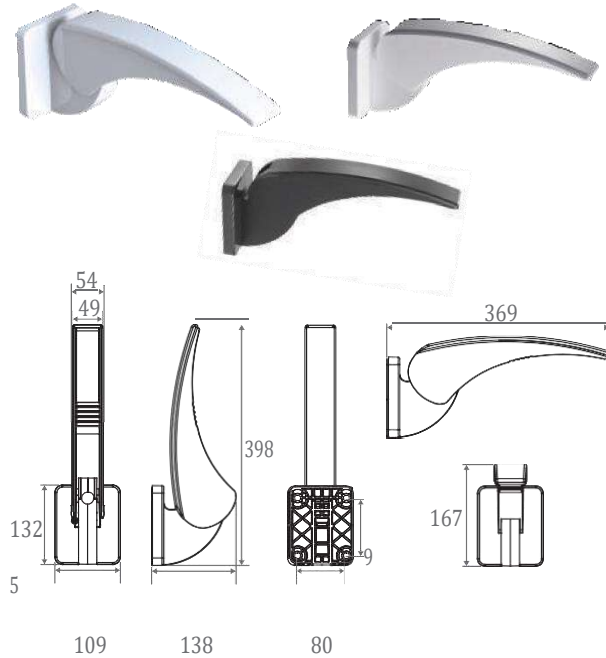

Descripción	Ref.	P.V.P.
Blanco White	047710	75,00 €
Blanco/Gris White/Grey	047711	75,00 €
Antracita Anthracite grey	047713	81,00 €

Para tener el apoyabrazos abatible desmontable, añadir el kit "click&fit" ref. 044110 (blanco) o 044113 (gris antracita)

To have the hinged armrest removable, add the «click&fit» plate kit ref. 044110 (white) or 044113 (anthracite grey))

.RESPALDOS

Backrests

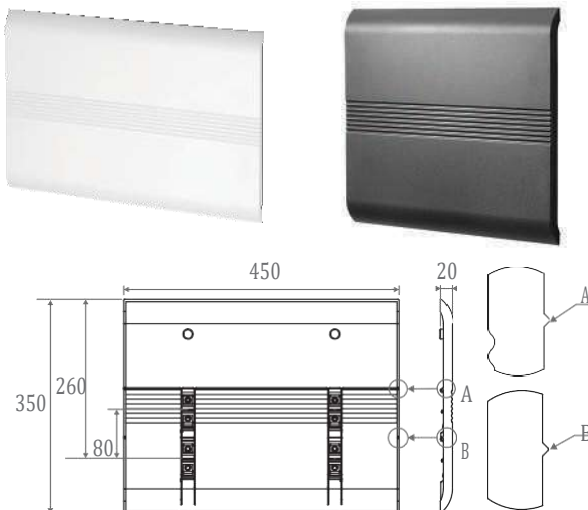

■ Blanco White	044720	45,00€
■ Antracita Anthracite grey	044723	45,00€

2 alturas ajustables posibles

Adjustable height: 2 positions.

Se vende por separado. La fijación del respaldo requiere un riel ref. 044240

Sold separately. The backrest fixing requires a rail ref. 044240.

COMPONENTES EVOLUTION

.RESPALDO + 2 APOYABRAZOS

Backrest + 2 armrests



Descripción	Ref.	P.V.P.
Blanco White	047720	288,00 €
Blanco/Gris White/Grey	047721	288,00 €
Antracita Anthracite grey	047723	299,50 €

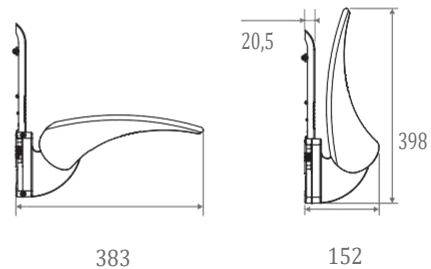
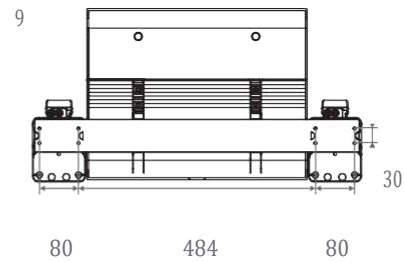
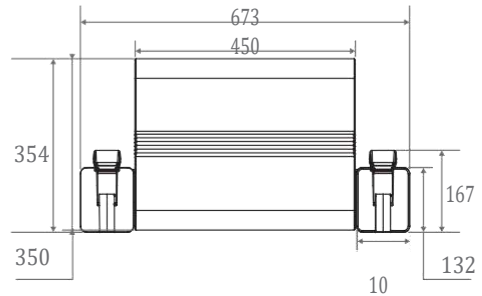

Vendido con el riel de fijación y las pletinas para apoyabrazos.

Sold with the fixing rail and plate adaptors for armrests.

.BARRAS DE APOYO EXTRAÍBLE

Removable grab bars

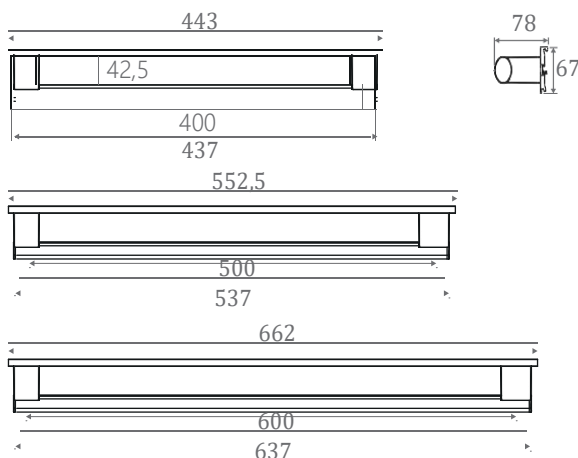

Descripción	Ref.	P.V.P.
Blanco/ Anodizado		
<i>White/Anodized</i>		
• 443 mm	044840	70,00 €
• 552,5 mm	044850	74,00 €
• 662 mm	044860	81,00 €
Antracita/Anodizado		
<i>Anthracite grey/Anodized</i>		
• 443 mm	044843	70,00 €
• 552,5 mm	044853	74,00 €
• 662 mm	044863	81,00 €

La fijación de las barras de apoyo requiere el riel ref. 044240, 044250 o 044260.

The grab bars fixing requires the rail of same dimension ref. 044240, 044250 or 044260.

.RIELES + TAPA

Rails + cover

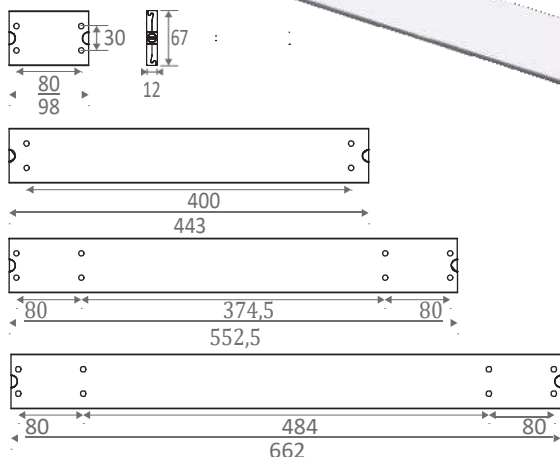
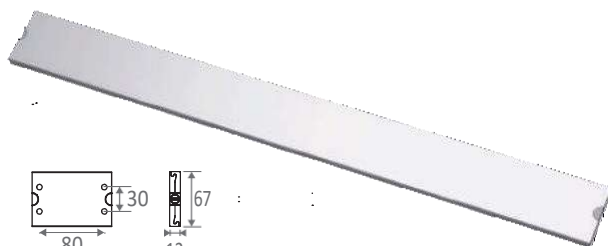

Anodizado/Blanco		
<i>Anodized/White</i>		
• 98mm	044010	42,00 €
• 443 mm	044040	69,50 €
• 552 mm	044050	82,00 €
• 662 mm	044060	91,10 €
Anodizado/Antracita		
<i>Anodized/Anthracite grey</i>		
• 98mm	044013	42,00 €
• 443 mm	044043	69,50 €
• 552 mm	044053	82,00 €
• 662 mm	044063	91,10 €

Viene con cerraduras. Kit completo diseñado para la actualización.

Sold with bolts. Complete kit designed for upgrading.

COMPONENTES EVOLUTION

.RIEL

Fixing rails

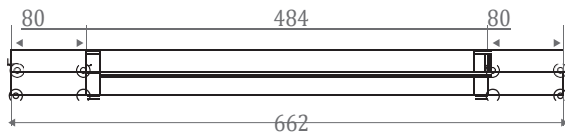
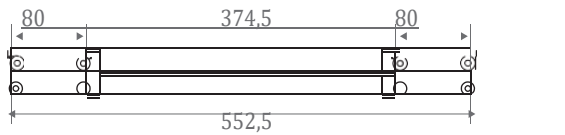
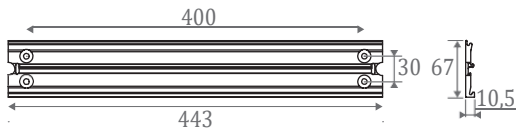
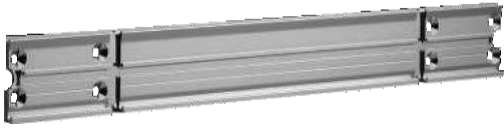

Descripción	Ref.	P.V.P.
Anodizado		
<i>Anodized</i>		
• 443 mm	044240	35,00 €
• 552,5 mm	044250	44,00 €
• 662 mm	044260	49,00 €

RIEL 400 = RESPALDO- Backrest

BARRA DE APOYO 443 mm -Grab bars 443 mm

RIEL 500 = RESPALDO + 1 APOYOABRAZO- Backrest
+ 1 armrest

RESPALDO + 1 BARRA ARTICULADA-Backrest
+ 1 hinged bar

BARRA DE APOYO 552 mm-Grab bar 552 mm

RIEL 600 = RESPALDO + 2 APOYOABRAZOS-Backrest + 2 armrests
RESPALDO + 2 BARRAS ARTICULADAS-Backrest + 2
hingedbars

BARRA DE APOYO 662 mm-Grab bar 662 mm

.TAPAS

Covers

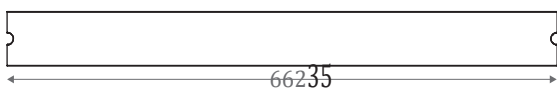
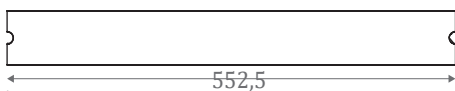
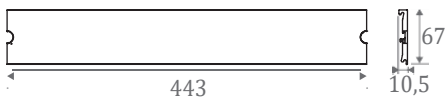

Anodizado		
<i>Anodized</i>		
• A = 443 mm	044340	31,50 €
• A = 552,5 mm	044350	37,00 €
• A = 662 mm	044360	41,50 €

.KIT PLETINA

"Click & fit" plate Kit

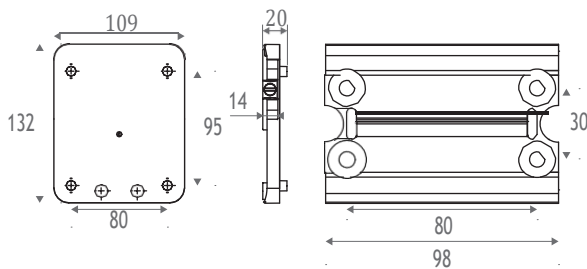
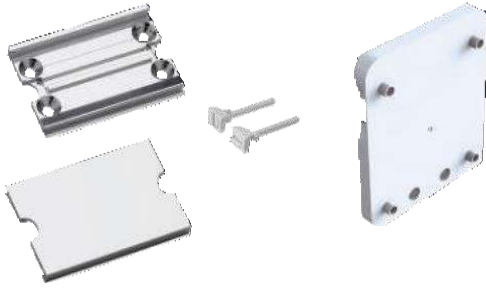

Descripción	Ref.	P.V.P.
KIT COMPLET Complete kit		
■ Blanco/Anodizado White/Anodized	044110	67,00 €
■ Antracita/Anodizado Anthracite grey/Anodized	044113	67,00 €

Kit completo compuesto por 1 riel de fijación + 1pletina de adaptada + 1 tapa.
Complete kit composed by 1 fixing rail + 1 plate adaptor + 1 cover.

.PLETINA

Plate adaptor

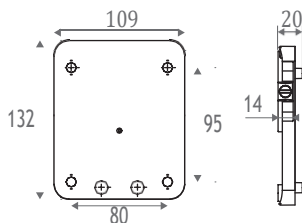

■ Blanco White	044710	39,50€
■ Antracita Anthracitegrey	044713	39,50€

Diseñada para hacer extraíble el apoyabrazos o la barra articulada. Se vende por separado.
Designed to make removable the armrest or hinged bar. Sold separately.

.CERROJOS

Bolts

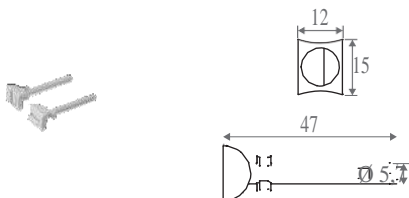

■ Blanco White	044700	8,00 €
■ Antracita Anthracitegrey	044703	8,00 €

CONSEJOS DE COLOCACIÓN

.RIEL 100



Instrucciones de montaje – Fitting instructions

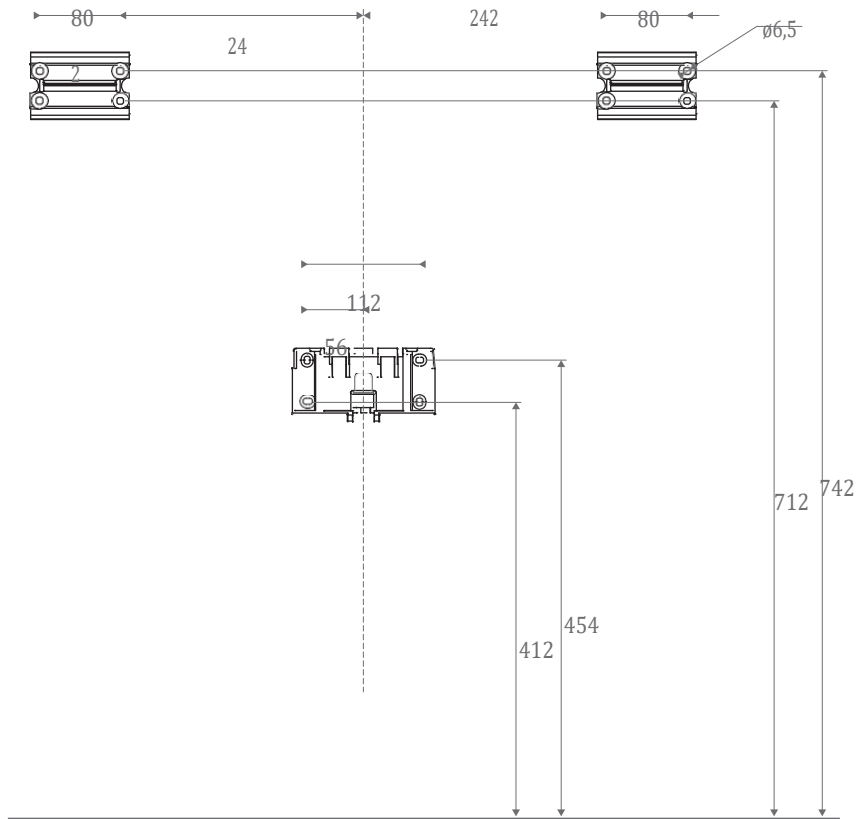

.RIEL 400



Instrucciones de montaje – Fitting instructions

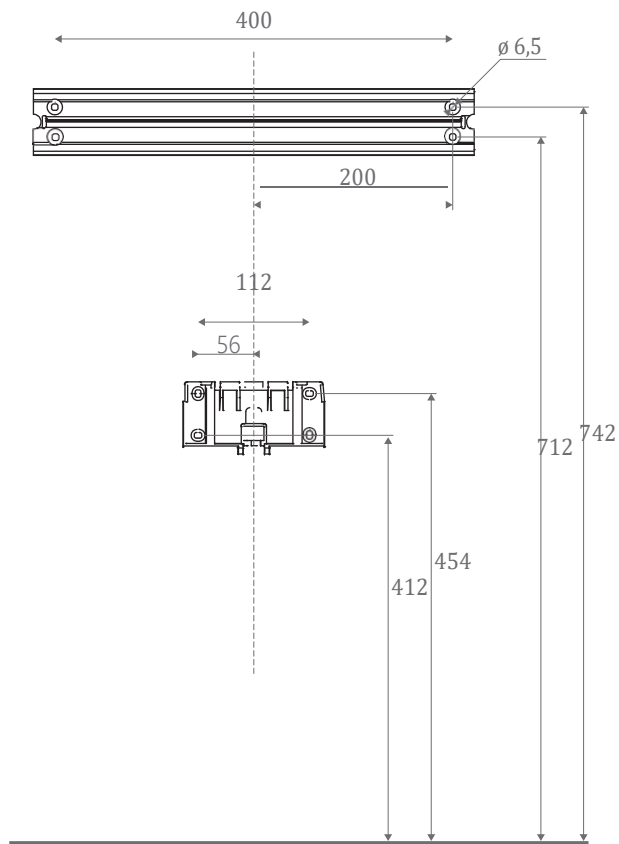

CONSEJOS DE COLOCACIÓN

RIEL 500



Instrucciones de montaje – Fitting instructions

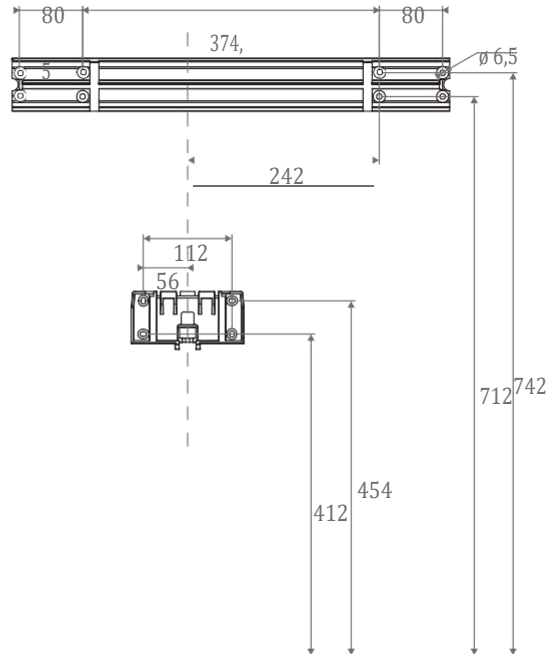
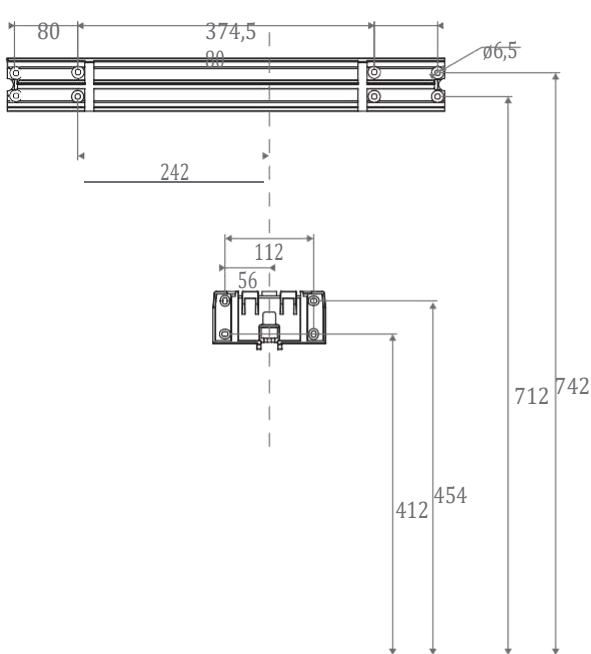



CONSEJOS DE COLOCACIÓN

.RIEL 600

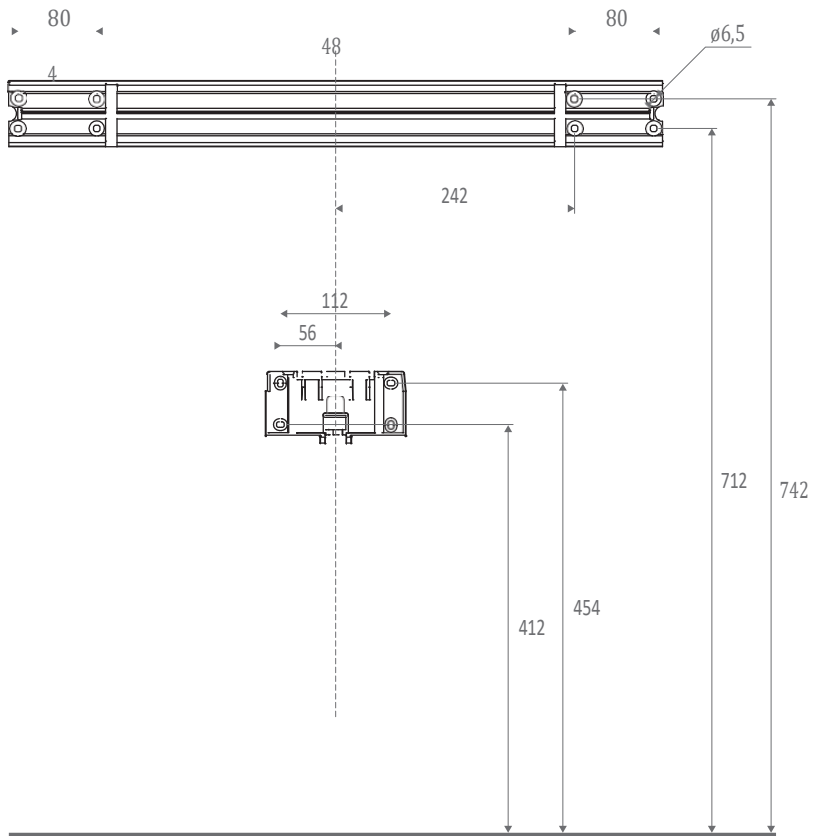

Instrucciones de montaje – Fitting instructions





ACCESORIOS SANITARIOS COLECTIVOS
BATHROOM ACCESSORIES

POLÍGONO UGALDEGUREN, I
48170 ZAMUDIO (VIZCAYA) - ESPAÑA

T. +34 94 471 00 64

F. +34 94 471 16 47

www.belaqua.es

comercial@belaqua.es

export@belaqua.es
